

# ● T-S24mm F3.5 ED AS UMC Instruction Manual

Thank you for purchasing the T-S24mm F3.5 ED AS UMC lens. We believe that you will have a special photographic experience with this new T-S24mm F3.5 ED AS UMC lens for video recording.

The T-S24mm F3.5 ED AS UMC lens is a retrofocus type lens which corrects and emphasizes perspective, and also adjusts the depth of field. The T-S24mm F3.5 ED AS UMC lens completes an optical system based on superior optical technologies, and maintains excellent resolution both at the center and around the periphery of the lens by adopting a high performance Glass Molding ASP lens and UMC (Ultra Multi Coating).

The tilt shift unit controls the depth of field to the subject and the shooting area. This lens compensates for image distortion and allows you to capture a variety of images that were never possible with the existing lenses.

Advantages of the T-S24mm F3.5 ED AS UMC lens

1. 35mm full frame image size.
2. It compensates for optical aberrations using a high performance aspherical glass lens.
3. In the fully open position it produces a high resolution and high contrast at the center of the lens, as well as around the periphery.
4. The UMC (Ultra Multi Coating) design suppresses flare and ghost images.

The T-S24mm F3.5 ED AS UMC lens is designed with its own mount, so you can take photographs easily by mounting the lens directly onto the camera, without installing an additional adaptor.

Read this manual carefully to familiarize yourself with your lens for correct use.

※ Please read the Safety Precautions at the back of this instruction manual prior to use.

## 2. Attaching and Detaching

When attaching or detaching the T-S24mm F3.5 ED AS UMC lens, make sure that the tilt scale and the shift scale are positioned at '0' and are locked. Failure to do so will make it difficult to attach a lens to the camera since the tilt or shift part moves.

### [Attaching]

Hold the tilt area of the lens gently and align the lens mounting reference point or line with the lens ring mount of the camera. Push the lens into the camera and gently turn the lens in the attachment direction until it makes a clicking sound.

### [Detaching]

Hold the tilt area of the lens gently, press the lens release button on the camera, turn the lens in the opposite direction to that for attaching, and pull it out.

## 3. Focus Adjustment

You can adjust the focus by turning the focusing ring when using the T-S24mm F3.5 ED AS UMC lens, as it is a Manual Focus (MF) adjustment lens. When using the tilt/shift function, you cannot check if the focus is correct using the distance scale of the lens.

If you have a camera which allows you to view images through the viewfinder or to capture a live view, check the focus while looking at an enlarged image. If you change the tilt and shift values after setting the focus, the subject will be out of focus.

### [Nikon Mount]

- ① To change the focus from a subject that is far away to a subject that is close, turn the focusing ring to the left (from  $\infty$  to 0.2 m) and focus on the clearest subject by using the indication signal on the camera or by checking visually.
- ② To change the focus from a subject that is close to a subject that is far away, turn the focusing ring to the left (from 0.2 m to  $\infty$ ) and focus on the clearest subject by using the indication signal on the camera or by checking visually.

### [Sony $\alpha$ / Canon Mount]

- ① To change the focus from a subject that is far away to a subject that is close, turn the focusing ring to the left (from 0.2 m to  $\infty$ ) and focus on the clearest subject by using the indication signal on the camera or by checking visually.
- ② To change the focus from a subject that is close to a subject that is far away, turn the focusing ring to the left (from  $\infty$  to 0.2 m) and focus on the clearest subject by using the indication signal on the camera or by checking visually.

Make sure to differentiate the knob for tilting. The tilting knob is black and the locking knob is gray. Use the black knob to adjust the tilting and rotate the gray knob in the L direction to hold it in place.

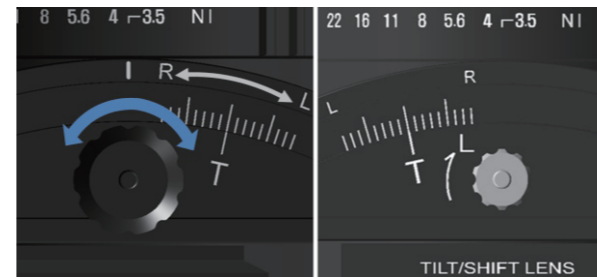

※ Caution

When you use the tilt function, make sure that you do not touch the sensitive parts of the tilt unit.

Do not turn the knobs with excessive force. Doing so may damage the knobs.

## 5-2. Shift control

The T-S24mm F3.5 ED AS UMC lens allows you to correct distortion of the subject by using the shift unit. It is recommended to use a tripod for proper shooting. Make sure to differentiate the knob for shifting.

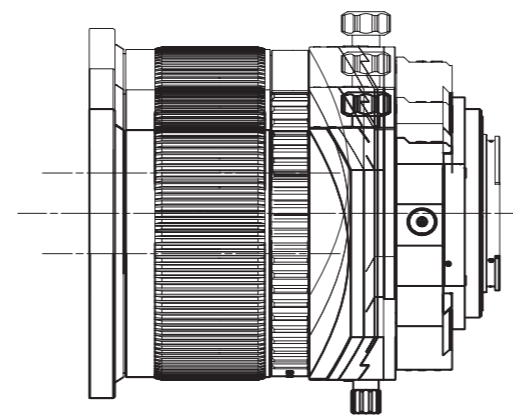

The shifting knob is black and the locking knob is gray. Use the black knob to adjust the shifting and rotate the gray knob in the L direction to hold it in place.

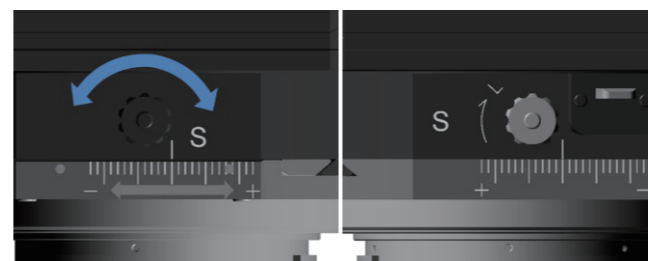

If the amount of shift is large, the lighting may be different at the top or bottom of the image, or on the left or right of the image. Therefore it is recommended to reduce the aperture value when shooting.

## 5-3. Lens rotation

The tilt/shift direction can be changed by turning the tilt/shift unit.

If you pull the mount rotation lever and the tilt rotation lever when the lens is mounted on the camera, you can rotate the tilt/shift unit. 90° rotation is available for the mount and tilt units. The lens is half secured at every 30 degrees and fully secured at 90 degrees. When rotation starts you can remove your hand from the rotation unlocking knob, since the rotation will continue.

If the lens is secured at 90 degrees, press the knob and turn it. Please note that there is a danger of pinching your finger in the locking lever when you rotate the tilt/shift unit quickly.

## 6. Camera Settings

Some cameras require special settings when using this lens.

### ○ Canon Mount

The diaphragm of the T-S24mm F3.5 ED AS UMC Canon mount is not compatible with the camera. If the brightness is set to F8 or above, you may not be able to set the correct focus due to a difficulty in viewing the subject through the camera viewfinder. Turn the aperture ring so it is fully open when attaching the lens to the camera, and then set the depth of field and brightness you want prior to shooting.

- 1) Set the camera mode dial to M.

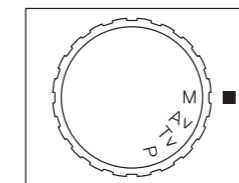

- 2) Adjust the shutter speed to achieve the appropriate exposure for the brightness.

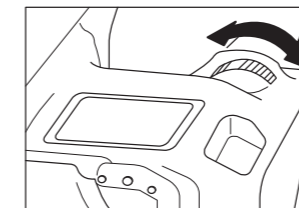

※ For some Canon cameras, if you set the camera mode dial to Av and set the brightness by turning the aperture ring on the lens, the camera automatically changes the shutter speed. You don't need to adjust the shutter speed as well, which is required in M mode.

(The procedures above are for the 40D. The settings for the camera or the menu may vary based on the model or due to a functional upgrade. Refer to the camera instruction manual or contact the camera manufacturer for detailed information.)

### ○ Nikon Mount

The diaphragm of the T-S24mm F3.5 ED AS UMC Nikon mount is not compatible with the camera.

If the brightness is set to F8 or above, you may not be able to set the correct focus due to a difficulty in viewing the subject through the camera viewfinder. Turn the aperture ring so it is fully open when attaching the lens to the camera, and then set the depth of field and brightness you want prior to shooting.

(The procedures above are for the D8000. The settings for the camera or the menu may vary based on the camera model or due to a functional upgrade. Refer to the camera manual or contact the camera manufacturer for detailed information.)

### ○ Pentax (Samsung GX) K Mount

The diaphragm of the T-S24mm F3.5 ED AS UMC Pentax (Samsung GX) K mount is not compatible with the camera.

If the brightness is set to F8 or above, you may not be able to set the correct focus due to a difficulty in viewing the subject through the camera viewfinder. Turn the aperture ring so it is fully open when attaching the lens to the camera, and then set the depth of field and brightness you want prior to shooting.

- 1) Set the mode dial of the camera to Av.

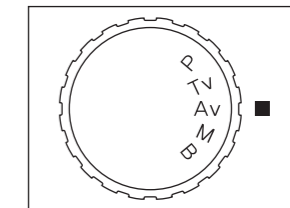

- 2) Set the focusing lever of the camera to MF.

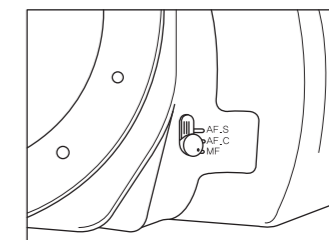

(The procedures above are for the K20D. The settings for the camera or the menu may vary based on the model or due to a functional upgrade. Refer to the camera instruction manual or contact the camera manufacturer for detailed information.)

### ○ Sony (Minolta) $\alpha$ Mount

The diaphragm of the T-S24mm F3.5 ED AS UMC Sony (Minolta)  $\alpha$  mount is not compatible with the camera.

If the brightness is set to F8 or above, you may not be able to set the correct focus due to a difficulty in viewing the subject through the camera viewfinder. Turn the aperture ring so it is fully open when attaching the lens to the camera, and then set the depth of field and brightness you want prior to shooting.

- 1) Set the camera mode dial to M.

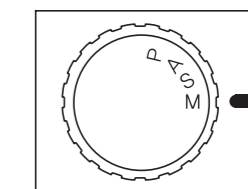

## 1. Component Names

[Figure]

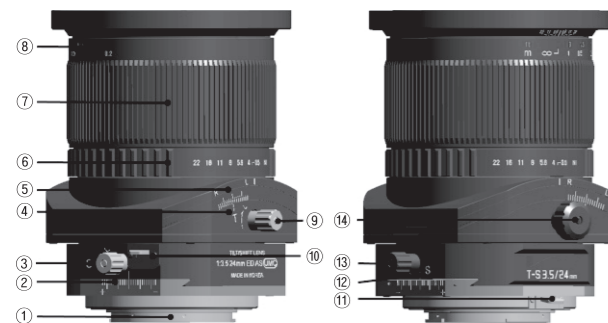

- |                       |                       |                        |
|-----------------------|-----------------------|------------------------|
| ① Mount               | ⑥ Aperture ring       | ⑪ Mount rotation lever |
| ② Shift scale         | ⑦ Focusing ring       | ⑫ Shift reference line |
| ③ Shift locking knob  | ⑧ Distance scale      | ⑬ Shift knob           |
| ④ Tilt reference line | ⑨ Tilt locking knob   | ⑭ Tilt knob            |
| ⑤ Tilt scale          | ⑩ Tilt rotation lever |                        |

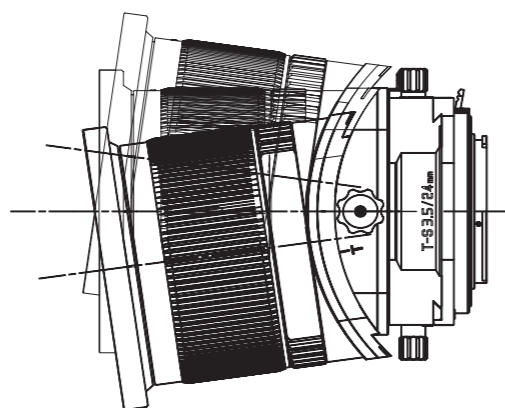

2) Set the focus adjustment lever of the camera to MF.

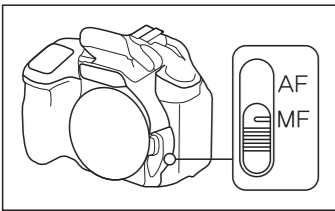

3) Adjust the shutter speed to achieve the appropriate exposure for the brightness by turning the dial.

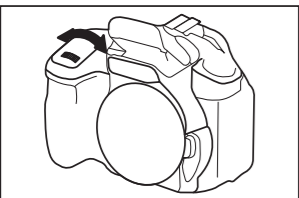

(The procedures above are for the α350. The settings for the camera or the menu may vary based on the model or due to a functional upgrade. Refer to the camera instruction manual or contact the camera manufacturer for detailed information.)

**[ Samsung NX Mount ]**

- 1) Set the camera mode dial to M.
- 2) Adjust the shutter speed by turning the dial to achieve the appropriate exposure for the brightness.

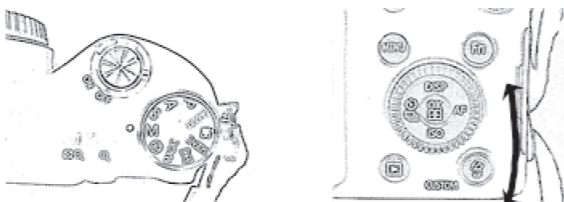

※ For some Samsung (NX) cameras, if you set the camera mode dial to A and set the brightness by turning the aperture ring on the lens, the camera automatically changes the shutter speed. Therefore you don't need to adjust the shutter speed as well, which is required in M mode.

(The procedures above are for the NEX-200. The settings for the camera or the menu may vary based on the model or due to a functional upgrade. Refer to the camera manual or contact the camera manufacturer for detailed information.)

**[ Four Thirds ]**

- 1) Hold down the MODE button and turn the dial until it is set to M. (shooting conditions)  
MODE + control dial ► M mode setting (manual shooting)

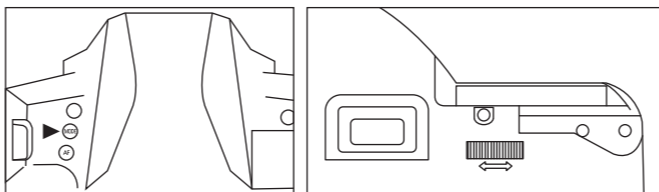

- 2) Hold down the AF button and turn the dial until it is set to MF. (Focusing)  
AF + control dial ► MF setting (manual focusing)

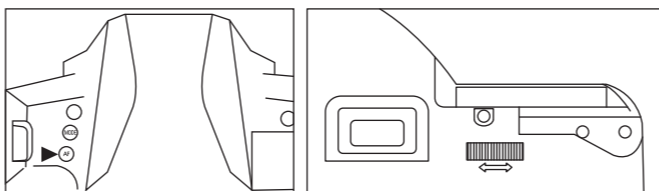

- 3) Adjust the shutter speed to achieve the appropriate exposure for the brightness by turning the dial.

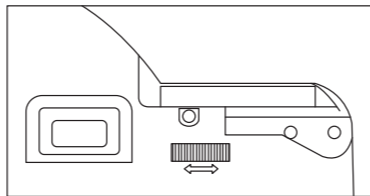

※ For some Four Thirds cameras, if you set the camera mode dial to A and set the brightness by turning the aperture ring on the lens, the camera automatically changes the shutter speed. Therefore you don't need to adjust the shutter speed as well, which is required in M mode.

(The procedures above are for the Olympus E-3. The settings for the camera or the menu may vary based on the camera model or due to a functional upgrade. Refer to the camera manual or contact the camera manufacturer for detailed information.)

**[ Micro Four Thirds Mount ]**

- 1) Set the camera mode dial to M.

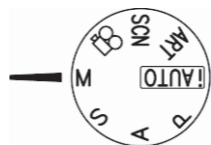

- 2) Adjust the shutter speed by turning the dial to achieve the appropriate exposure for the brightness.

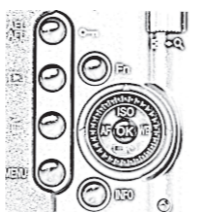

※ For some Olympus (MFT) and Panasonic (MFT) cameras, if you set the camera mode dial to A and set the brightness by turning the aperture ring on the lens, the camera automatically changes the shutter speed. Therefore you don't need to adjust the shutter speed as well, which is required in M mode.

(The procedures above are for the E-P2. The settings for the camera or the menu may vary based on the camera model or due to a functional upgrade. Refer to the camera manual or contact the camera manufacturer for detailed information.)

**7. Specifications**

SPECIFICATIONS	TILT/SHIFT LENS 1:3.5 24mm ED AS UMC									
APERTURE RANGE	F3.5 - 22									
OPTICAL CONSTRUCTION	16 ELEMENTS IN 11 GROUPS (2 ASPHERICAL LENS)									
MINIMUM FOCUSING DISTANCE	0.2m(0.65ft)									
FILTER SIZE	ø 82mm									
MAXIMUM DIAMETER	ø 86mm									
MOUNT	CANON EOS	NIKON	PENTAX K	SONY α	CANON M	FUJIFILM X	SAMSUNG NX	SONY E	FOUR-THIRDS	MICRO FOUR-THIRDS
ANGLE OF VIEW	35mm	83.5°	83.5°	83.5°	83.5°	-	-	83.5°	-	-
	APS-C	56.3°	59.9°	59.9°	59.9°	56.9°	59.9°	59.9°	-	-
	FOUR-THIRDS (4/3")	-	-	-	-	-	-	-	47.1°	47.1°
LENGTH	110mm	107mm	108mm	109mm	136mm	136mm	128mm	139mm	115mm	134mm
WEIGHT	667g	647g	646g	656g	737g	745g	727g	734g	720g	730g
LENS ROTATION	*Maximum Tilt amount: ±8.5°, Maximum Shift amount: ±12mm *Between Tilt and Shift Rotation: 90° Left(click-stop for each 30° step) *Mount Rotation: 90° Right(click-stop for each 30° step)									

**8. Troubleshooting**

Issue	Causes	Corrective Action
A lens cannot be attached to the camera.	The attachment reference point on the lens is not aligned with the lens attachment reference point on the camera.	Align the attachment reference point on the lens with the lens attachment reference point on the camera.
A lens cannot be detached from the camera.	Incorrect rotation direction for detaching the lens. If you turn the lens while holding the camera, it may cause damage to the lens.	Press the lens release button on the camera, and gently turn the lens to the lens attaching/detaching reference points, in the direction as marked on the camera, and then pull the lens forward.
Blurry images	Incorrect focusing Insufficient shutter speed or camera shake.	Turn the focusing ring while checking the indication or checking an object visually, set the focus until it becomes clear, and then press the shutter. Steady the camera and take a photograph at a shutter speed of 1/125 secs.
Automatic focusing does not work properly.	A manual focusing lens has trouble with automatic focusing.	Use the focusing ring to adjust the focus.
Dark or too bright pictures.	Inappropriate exposure	Adjust the aperture adjustment ring accordingly.
The camera flash is not functioning.	The manual control lens may not be compatible, depending on the camera.	See the camera manual.
The camera finder indication or the display does not display.	This lens does not have an electric contact signal, so there is no communication with the camera through electric signals.	No problem with shooting.
Zoom failure.	This lens is a single lens.	
This lens cannot be mounted on other cameras.	This lens is designed for its own mount.	Purchase the designated lens mount.
You want to attach our 2X or 1.4X converter lens.	Our converter is designed for the T (M42 screw) mount only. Therefore it cannot be used with this lens.	Use each company's own mount converter. However, be aware that auto focusing is unavailable.

**9. Safety Precautions**

The following precautions are divided into two types according to the level of danger.

**⚠ WARNING**  
If this instruction is not followed, it may cause death or severe injury to the user.

**⚠ CAUTION**  
If this instruction is not followed, it may cause death or severe injury to the user.

The following pictograms are used in the below precautions:  
 ⚠ Requires caution. Inside the pictogram it shows contents of precautions. (It shows outbreak of fire in the pictogram on the left.)  
 ⚡ Shows prohibition of dismantling in the pictogram on the left.  
 ⚠ Shows instruction. Inside the pictogram it shows contents of instructions. (It shows instruction of precaution in the pictogram on the left.)

**⚠ WARNING**

- Don't look at the sun through the lens. It may cause blindness.
- Don't leave the lens within reach of babies, as it may cause injury to the baby if the lens falls or is dropped.

**⚠ CAUTION**

- Attach the lens to the camera correctly and ensure the lens is held in place properly; otherwise the lens may become loose and cause an accident.
- Don't attempt to modify or alter the lens. It may lead to failure of the camera. Modified or altered lenses may not be repaired.
- Don't put excessive pressure on the lens attached to the camera; otherwise it may cause damage to the lens or to the camera mount. Be sure to hold the lens when operating or moving.
- Don't leave the lens in direct sunlight. It may cause a fire, depending on lenses that concentrate light on a close object.
- Ensure that the camera operates properly by checking the lens beforehand or by test shooting for important events such as a wedding ceremony and an overseas trip.
- Don't look at the sun directly through a camera with a lens attached. It may cause damage to one's eyesight.

**WARNING!**  
Do not wet this product or expose it to a moist environment. It may cause a fire or electric shock.

**CAUTION!**

- Do not use this product or store it close to devices that generate heat i.e., heaters, thermal regulators, stoves or stereo amplifiers.
- Do not leave the lens in conditions where drastic temperature changes can occur.
- Do not touch the surface of the lens by hand, and avoid making contact with sharp objects.
- Avoid dropping the lens.
- Do not soak the lens in water, and avoid water splashing onto the lens.
- If there are foreign bodies on the lens, use a lens cleaning kit only.
- If the lens hood is cut by the user, it may cause damage to the surface of the lens, as the surface of the lens may make contact with the floor.

**WARNING! CAUTION!**

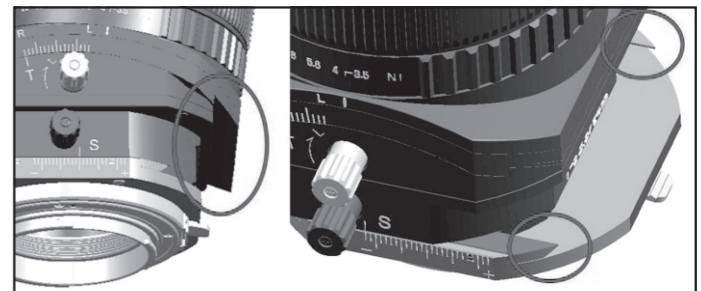

When using the tilt and shift functions, please be cautious and avoid touching the sharp surfaces of the lens as shown above picture.

**○ Mirrorless Cameras (Canon M, Samsung NX, Sony E, Fujifilm X)**

The diaphragms of the T-S24mm F3.5 ED AS UMC Canon M, Fujifilm X, Samsung NX and Sony E mounts are not compatible with the cameras. If the brightness is set to F8 or above, you may not be able to set the correct focus due to a difficulty in viewing the subject through the camera viewfinder. Turn the aperture ring so it is fully open when attaching the lens to the camera, and then set the depth of field and brightness you want prior to shooting.

**[ Canon M Mount ]**

- 1) Set the exposure to manual exposure (M) and change the focus mode to MF.

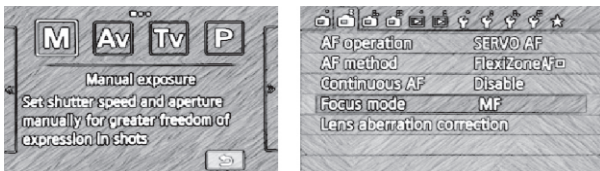

(The procedures above are for the Canon M. The settings for the camera or the menu may vary based on the camera model or due to a functional upgrade. Refer to the camera instruction manual or contact the camera manufacturer for detailed information.)

**[ FUJIFILM X Mount ]**

- 1) Set the focus mode to M.

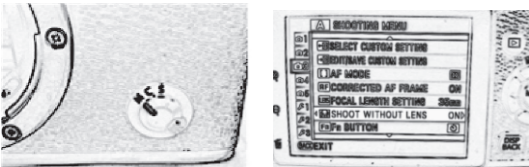

- 2) Press the MENU/OK button, and select ON at 'Shooting without lens' in the shooting menu.

(The procedures above are for the X-Pro1. The settings for the camera or the menu may vary based on the camera model or due to a functional upgrade. Refer to the camera instruction manual or contact the camera manufacturer for detailed information.)

**[ Sony E Mount ]**

- 1) Set the camera mode dial to M.
- 2) Adjust the shutter speed by turning the dial to achieve the appropriate exposure for the brightness.

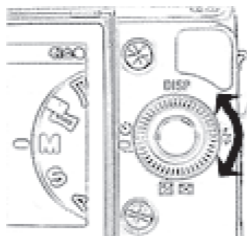

※ For some Sony E cameras, if you set the camera mode dial to A and set the brightness by turning the aperture ring on the lens, the camera automatically changes the shutter speed. Therefore you don't need to adjust the shutter speed as well, which is required in M mode.

(The procedures above are for the NEX-5. The settings for the camera or the menu may vary based on the model or due to a functional upgrade. Refer to the camera manual or contact the camera manufacturer for detailed information.)

**○ Four Thirds, Micro Four Thirds Mount**

The diaphragms of the T-S24mm F3.5 ED AS UMC Four Thirds and Micro Four Thirds mounts are not compatible with the cameras. If the brightness is set to F8 or above, you may not be able to set the correct focus due to a difficulty in viewing the subject through the camera viewfinder. Turn the aperture ring so it is fully open when attaching the lens to the camera, and then set the depth of field and brightness you want prior to shooting.